

16320

BUTYL BOTTOM BLACK DECK MOUNT FOR ASPHALT, EPDM, & TPO ROOFS



A DIVISION OF QUICKSCREWS INTERNATIONAL CORP

TABLE OF CONTENTS

3

SPEC SHEET
QTY & MEASUREMENT INFORMATION

6

UL CERTIFICATION
PROOF OF UL CERTIFICATION

8

INSTALLATION INSTRUCTIONS
STEP-BY-STEP-INSTALLATION GUIDE

9

BUILDING CODE LETTER
REGARDING STAMP DATES

10

ENGINEERING REPORT #1
LOAD TESTING - DIRECT TO DECK

25

ENGINEERING REPORT #2
LOAD TESTING - RAFTER MOUNTED

33

ENGINEERING REPORT #3
TAS 100(A)-95 WIND DRIVEN RAIN RESISTANCE

45

MIAMI-DADE NOA
MIAMI-DADE COUNTY NOTICE OF ACCEPTANCE

SPEC SHEET

Part #	Box Quantity
16320	36 Black Mounts + 144 Screws w/ EPDM Washers



PN# 16320
Screws

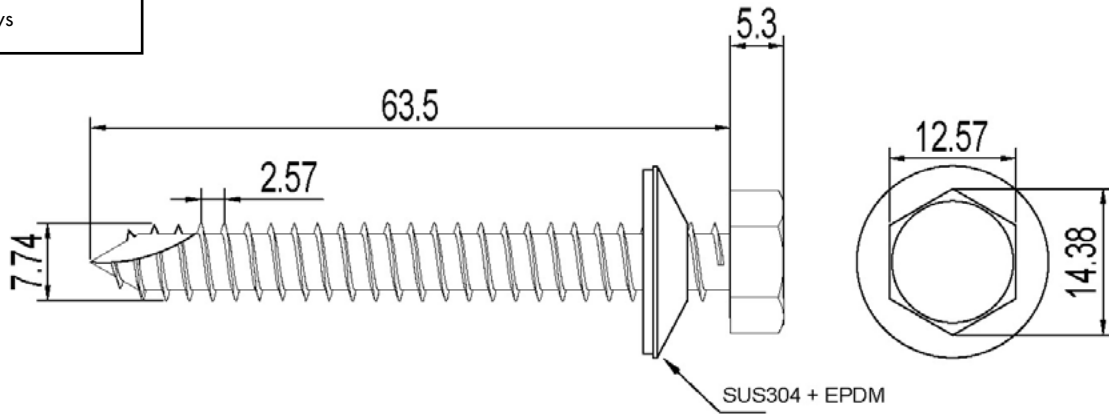

Tolerance Range				QuickBOLT			
Baiting tolerance	±2 mm			Scale	Quantity		
Hole tolerance	±0.3 mm						
Hole distance tolerance	±0.5 mm					Design	
Form tolerance	±2 mm					Drawing	
Thickness tolerance	±0.1 mm					Confirm	
Angle tolerance	±1° mm	Verify		Material			
				Drawing No.			
				Finish			

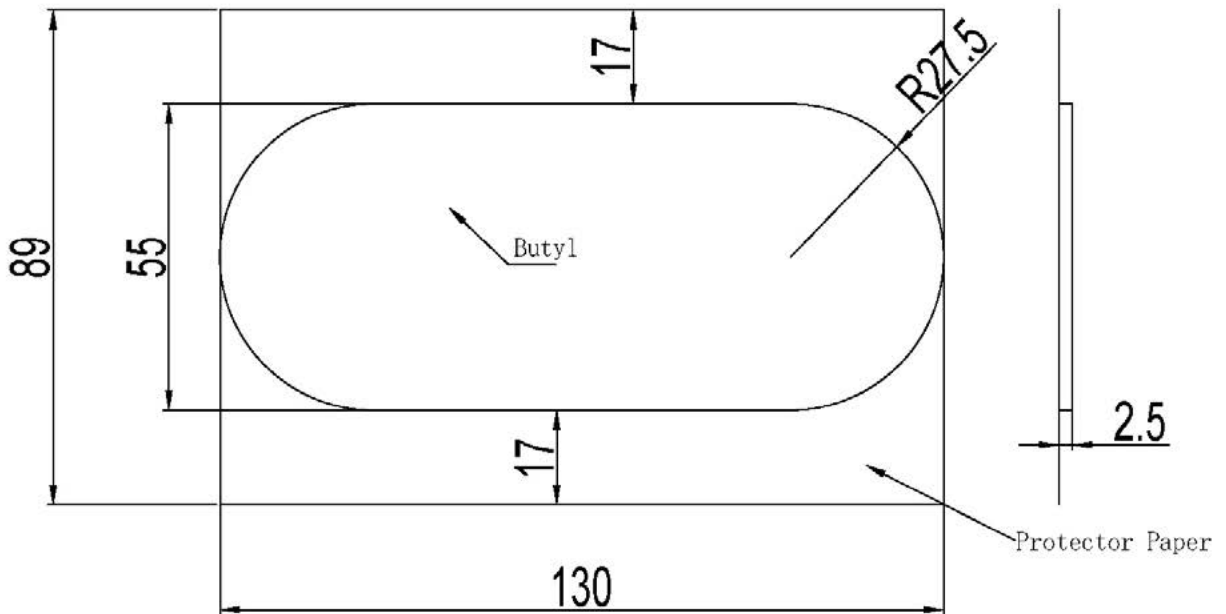

PN# 16320
Butyl backing

Tolerance Range				QuickBOLT			
Baiting tolerance	±2 mm			Scale	Quantity		
Hole tolerance	±0.3 mm						
Hole distance tolerance	±0.5 mm					Design	
Form tolerance	±2 mm					Drawing	
Thickness tolerance	±0.1 mm					Confirm	
Angle tolerance	±1° mm	Verify		Material	EPDM		
				Drawing No.			
				Finish			

PN# 16320
Black T-Foot

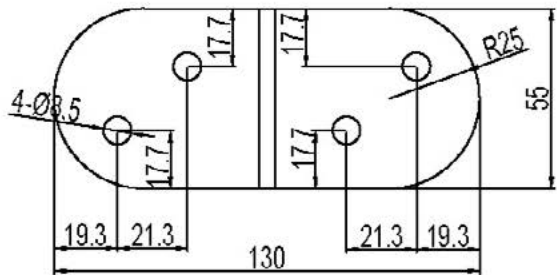
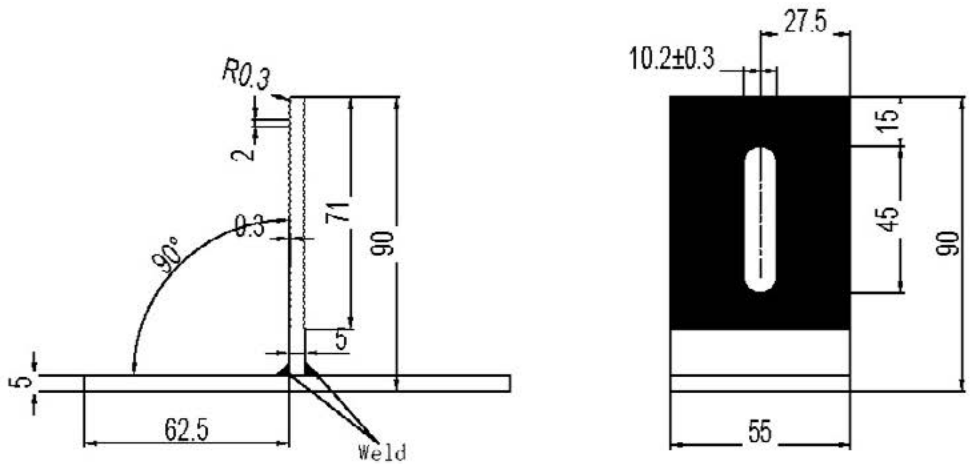

Tolerance Range						
Baiting tolerance	±2 mm					
Hole tolerance	±0.3 mm					
Hole distance tolerance	±0.5 mm	Design		Scale	Quantity	
Form tolerance	±2 mm	Drawing		Material	SUS304	
Thickness tolerance	±0.1 mm	Confirm				Drawing No.
Angle tolerance	±1° mm	Verify		16319 & 16320	Finish	

CERTIFICATE OF COMPLIANCE

Certificate Number E493748
Report Reference E493748-20170817
Date 2023-April-07

Issued to: QuickBOLT a Division of Quickscrews International Corp
5830 Las Positas Rd
Livermore CA, 94551 US

This is to certify that representative samples of MOUNTING SYSTEMS, MOUNTING DEVICES, CLAMPING DEVICES AND GROUND LUGS FOR USE WITH PHOTOVOLTAIC MODULES AND PANELS - COMPONENT
See Addendum Page for Product Designation(s).

Have been evaluated by UL in accordance with the component requirements in the Standard(s) indicated on this Certificate. UL Recognized components are incomplete in certain constructional features or restricted in performance capabilities and are intended for installation in complete equipment submitted for investigation to UL LLC.

Standard(s) for Safety: UL 2703, Mounting systems, mounting devices, clamping/retention devices, and ground lugs for use with flat-plate photovoltaic modules and panels-.

Additional Information: See the UL Online Certifications Directory at <https://iq.ulprospector.com> for additional information

This Certificate of Compliance indicates that representative samples of the product described in the certification report have met the requirements for UL certification. It does not provide authorization to apply the UL Recognized Component Mark. Only the Authorization Page that references the Follow-Up Services Procedure for ongoing surveillance provides authorization to apply the UL Mark.

Only those products bearing the UL Recognized Component Mark should be considered as being UL Certified and covered under UL's Follow-Up Services.

Look for the UL Recognized Component Mark on the product.



Deborah Jennings-Conner, VP Regulatory Services

UL LLC

Any information and documentation involving UL Mark services are provided on behalf of UL LLC (UL) or any authorized licensee of UL. For questions, please contact a local UL Customer Service Representative at <http://ul.com/aboutul/locations/>



CERTIFICATE OF COMPLIANCE

Certificate Number E493748
Report Reference E493748-20170817
Date 2023-April-07

This is to certify that representative samples of the product as specified on this certificate were tested according to the current UL requirements

Models:

USR – Component, Roof Mounting Hook Units, Models 15891 15893 15987 16000 16317 16318 16319 16320 16988 16990 16991 16993 17508 17509 17510 17511 17512 17513 17514 17515 17516 17517 17518 17519 17520 17521 17522 17523 17524 17525 17526 17527 17536 17537 17538 17539 17540 17541 17542 17543 17544 17545 17546 17547 17548 17549 17550 17551 17552 17553 17554 17555 17556 17558 17559 17560 17566 17567 17568 17569 17570 17571 17572 17573 17574 17575 17576 17577 17578 17579 17580 17585 17586 17587 17588 17589 17592 17596 17597 17598 17599 17600 17601 17606 17607 17608 17609 17610 17611 17612 17613 17614 17615 17616 17617 17618 17620 17621 17622 17623 17624 17625 17626 17627 17628 17629 17630 17631 17632 17633 17636 17637 17638 17639 17640 17641 17642 17643 17646 17647 17648 17649 17650 17651 17652 17653 17654 17659 17664 17667 17669 17670 17671 17672 17673 17678 17679 17680 17681 17686 17687 17688 17689 17700 17701 17702 17703 17704 17705 17706 17707 17708 17709 17710 17711 17712 17717 17718 17750 17751 17752 17753 17759 15891-10 15891BLK-10 15987A 15987B 17667SS 17672SS 17680SS 17688SS 17713SS 17720 17721SS 17723 17724SS 17726 17727SS 17729 17730SS 15894SS 15891SS 15987BSS 17660 17661 17662 17663 17747 17748

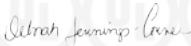

Deborah Jennings-Conner, VP Regulatory Services

UL LLC

Any information and documentation involving UL Mark services are provided on behalf of UL LLC (UL) or any authorized licensee of UL. For questions, please contact a local UL Customer Service Representative at <http://ul.com/aboutul/locations/>



INSTALL INSTRUCTIONS



BUTYL BOTTOM DECK MOUNT (16320) RECOMMENDED MATERIALS

- 1/2" Nut Setter

INSTALLATION INSTRUCTIONS

Install anywhere on roof. No need to locate rafters

1. Remove paper backing from bottom of T-Foot
2. Place T-Foot on roof and press firmly into place
3. Insert first 5/16 X 2 1/2" Hex Lag into T-Foot and drive the screw until the washer is compressed
4. Repeat with remaining screws

- * Do not predrill
- * To Drive Screws and Set Umbrella Washers Properly Torque PSI should not Exceed 57 Lbs/Inch

BUILDING CODE LETTER



March 22nd, 2023

To whom this may concern,

QuickBOLT is committed to excellence. The parts tested are durable goods, meaning the material composition and detailed specifications of the parts do not change. Therefore, all stamps are current. Any part tested will have the same results no matter what year the tests are performed. All testing and reports are current and valid with 2022 CBC standards.

SolarRoofHook is the previous name of QuickBOLT. Any test result referencing SolarRoofHook is referring to a QuickBOLT product.

All our parts were tested by a third-party test facility, in possession of a current engineering license for the state where the tests were performed for the following.

1. Uplift test
2. Downward load test
3. Lateral Test – Asphalt Mounts, and Metal Mounts only
4. ASTM E2440 and ASTM E330 Waterproof Tests - QuickBOLT only

The following is an excerpt from:

CALIFORNIA BOARD FOR PROFESSIONAL ENGINEERS AND LAND SURVEYORS
guide to Engineering & Land Surveying for City and County Officials
Page 12, Line 27

27. If the license has expired between the time the engineering documents were prepared and the time when the local agency's review is performed, do the documents need to be re-sealed by a licensee with a current license? (B&P Code §§ 6733, 6735, 6735.3, 6735.4)

As long as the license was current at the time the engineering documents were prepared, the documents do not need to be re-sealed prior to review by the local agency. However, any changes (updates or modifications) to the documents that are made following the review by the local agency would have to be prepared by a licensed engineer with a current license and those changes would have to be signed and sealed.

We trust the information provided will resolve any request for the test reports submitted to have a stamp from the current year.

Regards,

Rick Gentry
Executive Vice President

ENGINEERING REPORT #1

LOAD TESTING - DIRECT TO DECK



QUICKSCREWS INTERNATIONAL CORPORATION

MIAMI-DADE TEST REPORT

SCOPE OF WORK

ASTM D7147 BRACKET LOAD EVALUATIONS OF BUTYL BOTTOM DECK MOUNTS

REPORT NUMBER

Q6437.01-106-18 R0

TEST DATES

11/01/23 - 11/01/23

ISSUE DATE

11/17/23

RECORD RETENTION END DATE

11/01/33

PAGES

15

DOCUMENT CONTROL NUMBER

RT-R-AMER-Test-2827 (07/12/22)

© 2017 INTERTEK





Total Quality. Assured.

130 Derry Court
York, Pennsylvania 17406

Telephone: 717-764-7700
Facsimile: 717-764-4129
www.intertek.com/building

TEST REPORT FOR QUICKSCREWS INTERNATIONAL CORPORATION

Report No.: Q6437.01-106-18 R0

Date: 11/17/23

REPORT ISSUED TO

QUICKSCREWS INTERNATIONAL CORPORATION

5830 Las Positas Road
Livermore, California 94551

SECTION 1

SCOPE

Product: Butyl Bottom Deck Mount (16319/16320)

Architectural Testing, Inc. (an Intertek company) dba Intertek Building & Construction (B&C) was contracted by Quickscrews International Corporation to evaluate Butyl Bottom Deck Mount in accordance with ASTM D7147 for Bracket Loading. Results obtained are tested values and were secured by using the designated test method. Testing was conducted at the Intertek B&C test facility in York, Pennsylvania.

This report does not constitute certification of this product nor an opinion or endorsement by this laboratory.

Unless differently required, Intertek reports apply the "Simple Acceptance" rule, also called "Shared Risk approach," of ILAC-G8:09/2019, Guidelines on Decision Rules and Statements of Conformity.



For INTERTEK B&C:

COMPLETED BY:	Cag S. Saylor
TITLE:	Technician III Materials Laboratory
SIGNATURE:	 <small>Digitally Signed by: Cag Saylor</small>
DATE:	11/17/23

REVIEWED BY:	Tanya Dolby, P.E.
TITLE:	Manager Engineering Services
SIGNATURE:	 <small>Digitally Signed by: Tanya Dolby</small>
DATE:	2023.11.17 15:24:45 -05'00'

CSS:jmb/td/kae

This report is for the exclusive use of Intertek's Client and is provided pursuant to the agreement between Intertek and its Client. Intertek's responsibility and liability are limited to the terms and conditions of the agreement. Intertek assumes no liability to any party, other than to the Client in accordance with the agreement, for any loss, expense or damage occasioned by the use of this report. Only the Client is authorized to permit copying or distribution of this report and then only in its entirety. Any use of the Intertek name or one of its marks for the sale or advertisement of the tested material, product or service must first be approved in writing by Intertek. The observations and test results in this report are relevant only to the sample(s) tested. This report by itself does not imply that the material, product, or service is or has ever been under an Intertek certification program.



Total Quality. Assured.

130 Derry Court
York, Pennsylvania 17406

Telephone: 717-764-7700
Facsimile: 717-764-4129
www.intertek.com/building

TEST REPORT FOR QUICKSCREWS INTERNATIONAL CORPORATION

Report No.: Q6437.01-106-18 R0

Date: 11/17/23

SECTION 2

TEST METHODS

The specimens were evaluated in accordance with the following:

ASTM D7147-21, *Standard Test Specification for Testing and Establishing Allowable Loads of Joist Hangers*

SECTION 3

MATERIAL SOURCE

The materials were provided by Quickscrews International Corporation. The following were received in good condition on 4/13/23:

- Ten (10), Butyl Bottom Deck Mounts

Refer to the product description photos in Section 10 and the drawings in Section 11. The materials were tested as received, except for preparing test specimens from the original materials. Representative materials/test specimens will be retained by Intertek B&C for a minimum of four years from the test completion date.

SECTION 4

TEST EQUIPMENT

NAME	ICN
INSTRON Model UTM	INT02020
30 kN Load Cell	INT02023
Digital Caliper	INT02510



Total Quality. Assured.

130 Derry Court
York, Pennsylvania 17406

Telephone: 717-764-7700
Facsimile: 717-764-4129
www.intertek.com/building

TEST REPORT FOR QUICKSCREWS INTERNATIONAL CORPORATION

Report No.: Q6437.01-106-18 R0

Date: 11/17/23

SECTION 5

LIST OF OFFICIAL OBSERVERS

NAME	COMPANY
Cag S. Saylor	Intertek B&C
Joseph M. Brickner	Intertek B&C
Tanya Dolby, P.E.	Intertek B&C

SECTION 6

TEST PROCEDURE

All conditioning of test specimens and test conditions were at standard laboratory conditions unless otherwise reported. Refer to the test related photos in Section 10. Calibration certificates are available on request.

ASTM D7147 - Vertical, Torsional, and Bending Loads

Specimens for the load tests were assembled out of nominal 2" x 4" lumber frames covered with 19/32" thick plywood and GAF Timberline HDZ shingles. The Butyl Bottom Deck Mounts were centered and fastened with 4, 5/16" x 2-1/2" lag screws into the frame through the plywood without a center joist. Three specimens were tested per configuration (See Drawing in Section 11). Specimens were tested utilizing a INSTRON UTM (ICN: INT02020) equipped with a 30 kN load cell (ICN: INT02023) and loaded in tension or compression at a rate of 0.10 in/min depending on the configuration. Maximum load and displacement were recorded.

SECTION 7

TEST SPECIMEN DESCRIPTIONS

TEST PROCEDURE	NUMBER OF SPECIMENS	NOMINAL SPECIMEN DIMENSIONS
ASTM D7147 – Vertical, Torsional, Bending Loading Tests	3 per configuration	16" x 16" x 4"



Total Quality. Assured.

130 Derry Court
York, Pennsylvania 17406

Telephone: 717-764-7700
Facsimile: 717-764-4129
www.intertek.com/building

TEST REPORT FOR QUICKSCREWS INTERNATIONAL CORPORATION

Report No.: Q6437.01-106-18 R0

Date: 11/17/23

SECTION 8

TEST RESULTS

Vertical Loading (Configuration F1, See Drawing in Section 11)

SPECIMEN NO.	MAXIMUM LOAD (lbf)	DISPLACEMENT (in)
1 – 16319,16320	1,410	0.646
2 – 16319,16320	1,150	0.544
3 – 16319,16320	1,360	0.602
Average	1,310	0.597
Std. Dev.	137	0.05

Torsional Loading (Configuration F2, See Drawing in Section 11)

SPECIMEN NO.	MAXIMUM LOAD (lbf)	DISPLACEMENT (in)
1 – 16319,16320	460	0.960
2 – 16319,16320	406	1.309
3 – 16319,16320	513	0.703
Average	460	0.991
Std. Dev.	53.5	0.304

Bending Load (Configuration F3, See Drawing in Section 11)

SPECIMEN NO.	MAXIMUM LOAD (lbf)	DISPLACEMENT (in)
1 – 16319,16320	1,010	0.599
2 – 16319,16320	1,080	0.564
3 – 16319,16320	1,130	0.463
Average	1,073	0.542
Std. Dev.	60.3	0.071

SECTION 9

CONCLUSION

The requested test method does not contain specific performance requirements. Results are reported as obtained.

TEST REPORT FOR QUICKSCREWS INTERNATIONAL CORPORATION

Report No.: Q6437.01-106-18 R0

Date: 11/17/23

SECTION 10
PHOTOGRAPHS



Photo No. 1
Material as Received



Photo No. 2
Specimen Test Deck

TEST REPORT FOR QUICKSCREWS INTERNATIONAL CORPORATION

Report No.: Q6437.01-106-18 R0

Date: 11/17/23



Photo No. 3
ASTM D7147 - Configuration F3 Test Setup



Photo No. 4
ASTM D7147 - Configuration F3 Test in Progress

TEST REPORT FOR QUICKSCREWS INTERNATIONAL CORPORATION

Report No.: Q6437.01-106-18 R0

Date: 11/17/23



Photo No. 5
ASTM D7147 - Configuration F3 Test in Progress



Photo No. 6
ASTM D7147 - Configuration F2 Test Setup

TEST REPORT FOR QUICKSCREWS INTERNATIONAL CORPORATION

Report No.: Q6437.01-106-18 R0

Date: 11/17/23



Photo No. 7
ASTM D7147 - Configuration F2 Test in Progress



Photo No. 8
ASTM D7147 - Configuration F2 Test in Progress

TEST REPORT FOR QUICKSCREWS INTERNATIONAL CORPORATION

Report No.: Q6437.01-106-18 R0

Date: 11/17/23



Photo No. 9

ASTM D7147 – Configuration F1 Vertical Load Test Setup



Photo No. 10

ASTM D7147 – Configuration F1 Vertical Load Test in Progress

TEST REPORT FOR QUICKSCREWS INTERNATIONAL CORPORATION

Report No.: Q6437.01-106-18 R0

Date: 11/17/23



Photo No. 11

ASTM D7147 – Configuration F1 Vertical Load Test in Progress



Photo No. 12

ASTM D7147 – Configuration F1 Vertical Load Test in Progress

TEST REPORT FOR QUICKSCREWS INTERNATIONAL CORPORATION

Report No.: Q6437.01-106-18 R0

Date: 11/17/23

SECTION 11

DRAWINGS

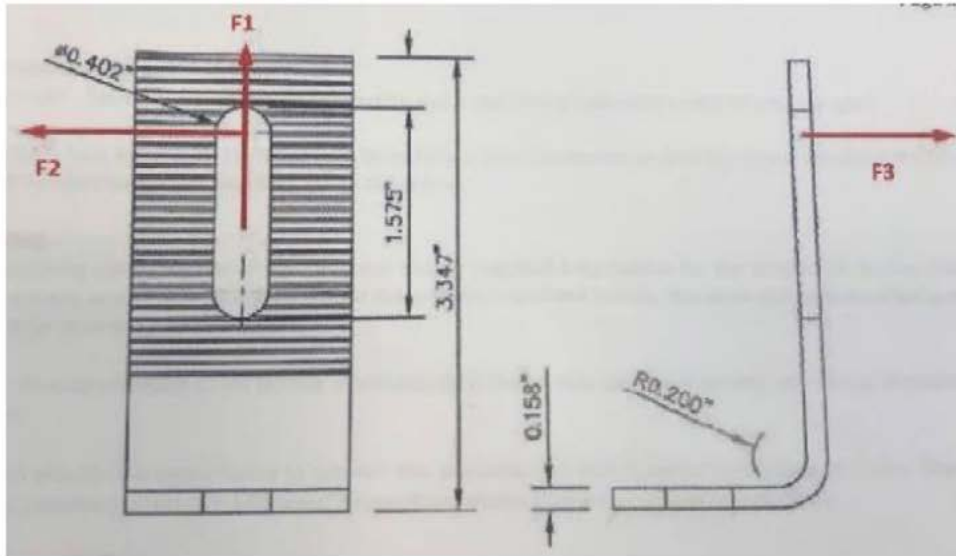

Load Orientation Details

BUTYL DECK MOUNT - QUICKBOLT PN16319/16320

GENERAL NOTES:

1. THIS SYSTEM HAS BEEN DESIGNED AND TESTED TO MEET ALL OF THE REQUIREMENTS OF THE 8TH EDITION (2023) FLORIDA BUILDING CODE, INCLUDING THE HMZ PROVISIONS.
2. THIS SYSTEM HAS BEEN TESTED PER TAS 100(A) AND ASTM D7147.
3. THE DESIGN OF THE SUBSTRATE IS THE RESPONSIBILITY OF THE ENGINEER OF RECORD OR OTHER SPECIALTY ENGINEER, AND IS NOT A PART OF THIS APPROVAL. THE SUBSTRATE MUST SAFELY TRANSMIT THE LOADS APPLIED TO THIS SYSTEM TO THE BUILDING STRUCTURE.
4. FIRE RATINGS OR FIRE RESISTANCE IS NOT A PART OF THIS REVIEW.
5. ALL ANCHORS SECURING THE SYSTEM TO PRESSURE TREATED WOOD SHALL BE CAPABLE OF RESISTING CORROSION CAUSED BY THE CHEMICALS IN THE WOOD.
6. MATERIALS INCLUDING BUT NOT LIMITED TO STEEL METAL SCREWS THAT COME INTO CONTACT WITH OTHER DISSIMILAR MATERIALS SHALL BE PROTECTED PER FBC REQUIREMENTS.
7. NO INCREASE IN ALLOWABLE STRESS HAS BEEN USED IN THE DESIGN OF THIS PRODUCT.

TOP VIEW BUTYL DECK MOUNT

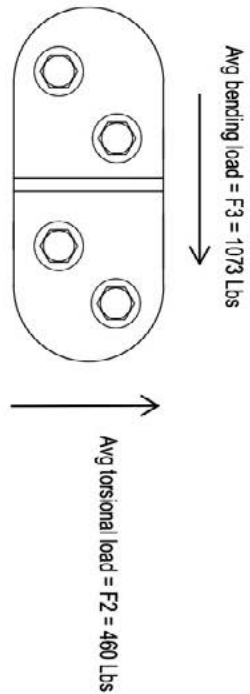

SIDE VIEW BUTYL DECK MOUNT

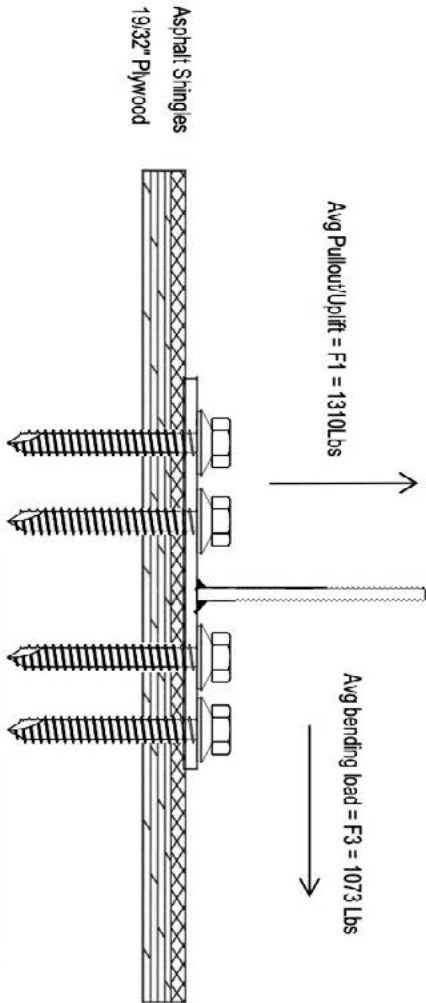

Intertek <small>Real Quality. Always.</small>	Report #:	Q6437.01
	Date:	11/15/23
	Verified by:	<i>[Signature]</i>



BUTYL DECK MOUNT - QUICKBOLT PN16319/16320

Measurements are in mm

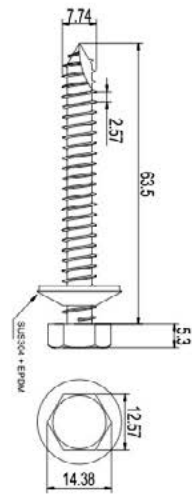
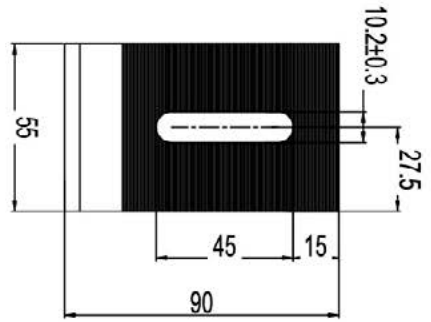
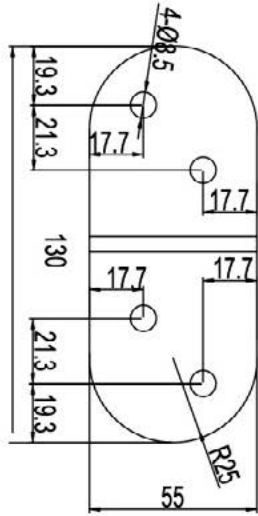
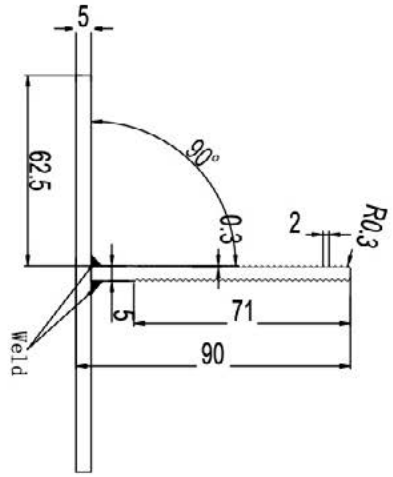

<p>Intertek Real Quality. Real Service.</p>	Report #:	Q6437.01
	Date:	11/15/23
	Verified by:	<i>[Signature]</i>

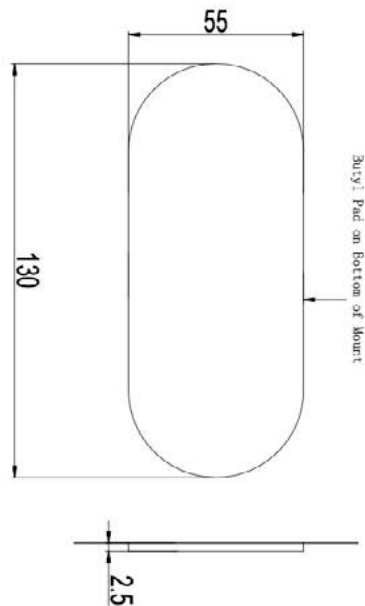



Total Quality. Assured.

130 Derry Court
York, Pennsylvania 17406

Telephone: 717-764-7700
Facsimile: 717-764-4129
www.intertek.com/building

TEST REPORT FOR QUICKSCREWS INTERNATIONAL CORPORATION

Report No.: Q6437.01-106-18 R0

Date: 11/17/23

SECTION 12

REVISION LOG

REVISION #	DATE	PAGES	REVISION
0	11/17/23	N/A	Original Report Issue

ENGINEERING REPORT #2

LOAD TESTING - RAFTER MOUNTED



APPLIED MATERIALS & ENGINEERING, INC.

980 41st Street
Oakland, CA 94608

Tel: (510) 420-8190
FAX: (510) 420-8186
e-mail: info@appmateng.com

January 4, 2023

Mr. Rick Gentry
QUICKSCREWS INTERNATIONAL
5830 Las Positas Road
Livermore, CA 94551

Project Number 1220938C

Subject: Deck Mount Butyl Kit 36M-144S/CS (Part # 16319, 16320) Laboratory Load Testing

Dear Mr. Gentry:

As requested, Applied Materials & Engineering, Inc. (AME) has completed load-testing the Deck Mount Butyl Kit 36M-144S/CS (Part # 16319). The purpose of our testing was to evaluate the tensile and shear load capacity of the Deck Mount attached to a 2"x6" Douglas Fir rafter using four (4) 5/16"Øx2-1/2" lag screws.

SAMPLE DESCRIPTION

Six Deck Mount Butyl Kits with 2"x6" Douglas Fir samples were delivered to our laboratory on December 9, 2022. Mockup configuration consisted of three 12" long rafters at 6.5" o.c., screwed to 1/2" Structural I plywood. The Deck Mount is attached through the plywood into a rafter with four 5/16"Øx2-1/2" lag screws.

TEST PROCEDURES & RESULTS

1. Tensile Load Test

A total of three tests were conducted for tensile (uplift) load capacity on December 28, 2022 using a United Universal testing machine. Samples were rigidly attached to the testing machine and a tensile load was applied to the hook. The samples were loaded in tension at a constant rate of axial deformation of 0.10 in./min. without shock until failure occurred; displacement at maximum load was recorded. Based on the above testing, the average maximum tensile load and displacement of the Deck Mount Butyl Kit attached to a 2"x6" Douglas Fir rafter using four 5/16"Øx2-1/2" lag screws was determined to be 3238 lbf and 0.4 in., respectively. Detailed results are provided in Table I and tensile load vs. displacement curves are provided in Figure 1. Test setup and mode of failure are provided in Appendix A, Figure 3.

The specific gravity and moisture content of the rafter was tested in accordance with ASTM D2395, Method A (oven-dry). The average specific gravity and moisture content were determined to be 0.493 and 16.3%, respectively.

Mr. Rick Gentry

Quickscrews International

Deck Mount Butyl Kit 36M-144S/CS (Part # 16319, 16320) Laboratory Load Testing

January 4, 2023

3. Shear Load Test Parallel to Rafter

A total of three tests were conducted for shear load capacity parallel to the rafter on December 29, 2022 using a United Universal testing machine. Samples were rigidly attached to the testing machine and a tensile load was applied to the hook. The samples were loaded in compression at a constant rate of axial deformation of 0.10 in. /min. without shock until failure occurred; displacement at maximum load was recorded. Based on the above testing, the average maximum tensile load and displacement of the Deck Mount Butyl Kit attached to a 2"x6" Douglas Fir rafter using four 5/16"Øx2-1/2" lag screws was determined to be 5234 lbs and 2.1 in., respectively. Detailed results are provided in Table II and shear load vs. displacement curves are provided in Figure 2. Test setup and mode of failure are provided in Appendix A, Figure 4.

The specific gravity and moisture content of the rafter was tested in accordance with ASTM D2395, Method A (oven-dry). The average specific gravity and moisture content were determined to be 0.448 and 17.7%, respectively.

Respectfully Submitted,

APPLIED MATERIALS & ENGINEERING, INC.

Reviewed by:

Armen Tajirian, Ph.D., P.E.
Principal

TABLE 1

TENSILE (UPLIFT) LOAD TEST RESULTS

DECK MOUNT BUTYL KIT 36M-144S/CS (Part # 16319, 16320)

PROJECT NUMBER 1220938C

TEST NUMBER	MAXIMUM TENSILE LOAD (lbf)	DISPLACEMENT AT MAXIMUM LOAD (in.)	MODE OF FAILURE	RAFTER SPECIFIC GRAVITY	RAFTER MOISTURE CONTENT (%)
8173	3613	0.4	Rafter Split	0.508	15.4
8174	2949	0.4		0.411	19.2
8175	3153	0.3		0.560	14.2
AVERAGE	3238	0.4	..	0.493	16.3

TENSILE LOAD-DISPLACEMENT CURVES



Report No 1639 Tensile Test - XHD Control

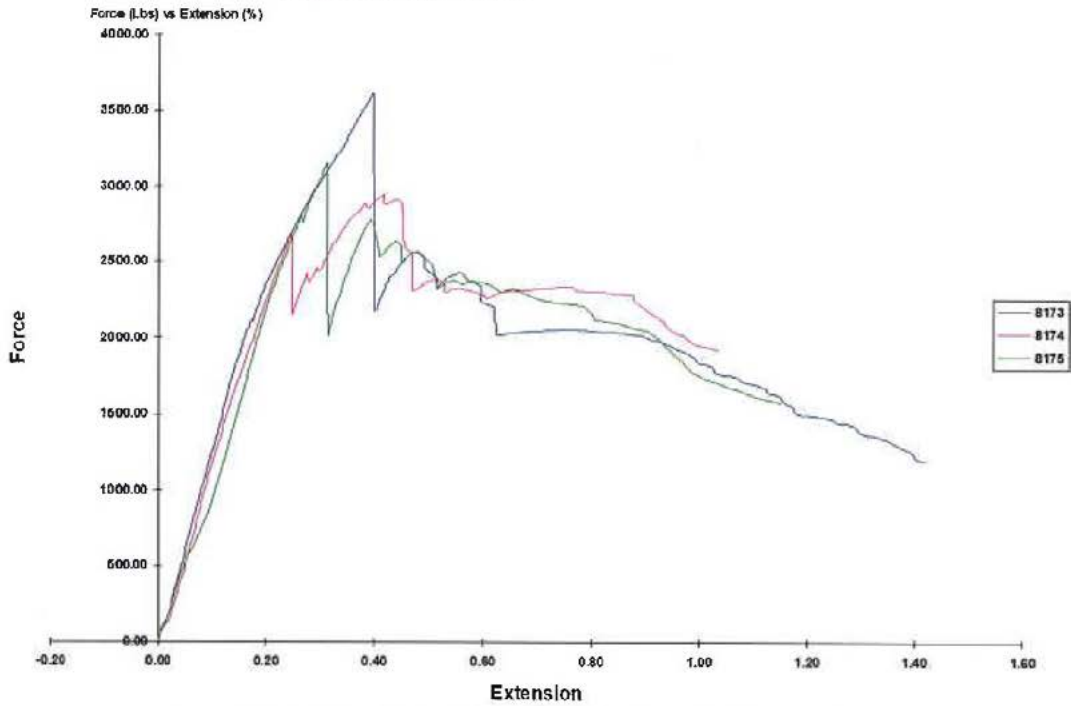

Figure 1. Test 8173, 8174, 8175 tensile load vs. displacement curve.

TABLE II

SHEAR LOAD TEST RESULTS

DECK MOUNT BUTYL KIT 36M-144S/CS (Part # 16319, 16320)

PROJECT NUMBER 1220938C

TEST NUMBER	MAXIMUM SHEAR LOAD (lbf)	DISPLACEMENT AT MAXIMUM LOAD (in.)	MODE OF FAILURE	RAFTER SPECIFIC GRAVITY	RAFTER MOISTURE CONTENT (%)
8176	7180	2.5	Bolt Shear	0.425	18.4
8177	4744	2.0	Mount Break	0.518	15.0
8178	3778	1.9	Mount Break	0.400	19.9
AVERAGE	5234	2.1	..	0.448	17.7

SHEAR LOAD-DISPLACEMENT CURVES



Report No 1640 Compressive Test - XHD Control
Force (-Lbs) vs Extension (-Inches)

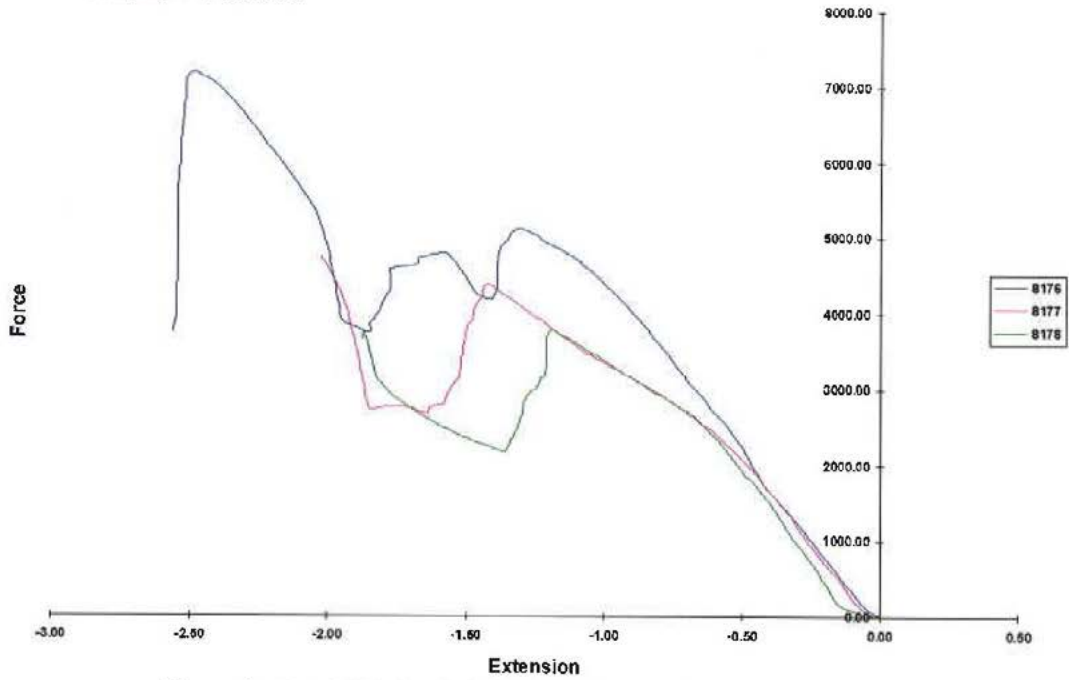

Figure 2. Test 8176, 8177, 8178 shear load vs. displacement curve.

FIGURE 3

DECK MOUNT BUTYL KIT 36M-144S/CS (Part # 16319, 16320)

TENSILE (UPLIFT) LOAD TEST SETUP

PROJECT NUMBER 1220938C



Figure 3a. Test setup.

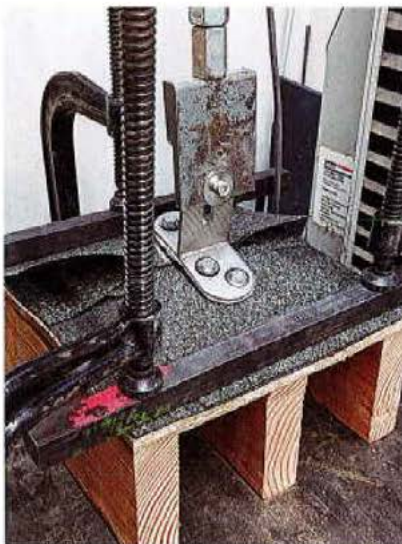

Figure 3b. Typical failure mode.



Figure 3c. Rafter view of typical failure

FIGURE 4

DECK MOUNT BUTYL KIT 36M-144S/CS (Part # 16319, 16320)

SHEAR LOAD TEST SETUP

PROJECT NUMBER 1220938C



Figure 4a. Test setup.



Figure 4b. Mount failure mode.



Figure 4c. Bolt failure mode.

ENGINEERING REPORT #3

TAS 100 (A)-95, WIND DRIVEN RAIN RESISTANCE



QUICKSCREWS INTERNATIONAL CORPORATION

MIAMI-DADE TEST REPORT

SCOPE OF WORK

TAS 100(A)-95 TESTING ON THEIR QUICKBOLT, BUTYL BOTTOM DECK MOUNT (PN#16319/16320)

REPORT NUMBER

P9590.02-109-18

TEST DATE(S)

07/13/23

ISSUE DATE

08/07/23

MIAMI-DADE COUNTY NOTIFICATION NO.

ATI - 23006

LABORATORY CERTIFICATION NO.

22-0428.14

PAGES

16

DOCUMENT CONTROL NUMBER

RT-R-AMER-Test-7808 (07/12/22)

© 2019 INTERTEK

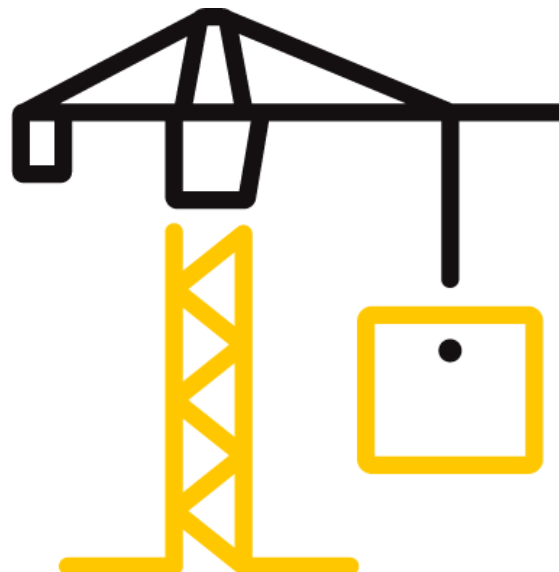



Total Quality. Assured.

130 Derry Court
York, Pennsylvania 17406

Telephone: 717-764-7700
Facsimile: 717-764-4129
www.intertek.com/building

TEST REPORT FOR QUICKSCREWS INTERNATIONAL CORPORATION

Report No.: P9590.02-109-18

Date: 08/07/23

REPORT ISSUED TO

QUICKSCREWS INTERNATIONAL CORPORATION

5830 Las Positas Road
Livermore, California 94551

SECTION 1

SCOPE

Architectural Testing, Inc. (an Intertek company) dba Intertek Building & Construction (B&C) was contracted by Quickscrews International Corporation to perform TAS 100(A) testing in accordance with Miami-Dade County requirements on their Butyl Bottom Deck Mount (PN#16319/16320), solar mount. Results obtained are tested values and were secured by using the designated test method(s). Testing was conducted at the Intertek B&C test facility in York, Pennsylvania.

SECTION 2

SUMMARY OF TEST RESULTS

The specimen(s) tested met the performance requirements set forth in the protocols.

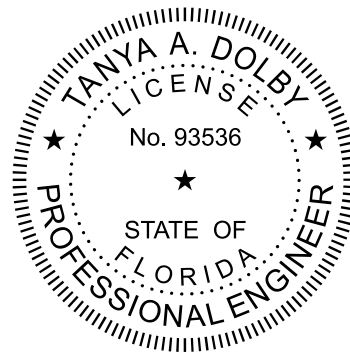

For INTERTEK B&C:

COMPLETED BY: Christopher E. Sartalis

TITLE: Technician – Product Testing

SIGNATURE: 
Digitally Signed by: Christopher Sartalis

DATE: 08/07/23

REVIEWED BY: Tanya A. Dolby, P.E.

TITLE: Engineering Manager – Engineering Services

SIGNATURE: 
Digitally Signed by: Tanya Dolby

DATE: 08/07/23

CES:bsm

2023.08.08 14:38:41 -04'00'

This report is for the exclusive use of Intertek's Client and is provided pursuant to the agreement between Intertek and its Client. Intertek's responsibility and liability are limited to the terms and conditions of the agreement. Intertek assumes no liability to any party, other than to the Client in accordance with the agreement, for any loss, expense or damage occasioned by the use of this report. Only the Client is authorized to permit copying or distribution of this report and then only in its entirety. Any use of the Intertek name or one of its marks for the sale or advertisement of the tested material, product or service must first be approved in writing by Intertek. The observations and test results in this report are relevant only to the sample(s) tested. This report by itself does not imply that the material, product, or service is or has ever been under an Intertek certification program.



Total Quality. Assured.

130 Derry Court
York, Pennsylvania 17406

Telephone: 717-764-7700
Facsimile: 717-764-4129
www.intertek.com/building

TEST REPORT FOR QUICKSCREWS INTERNATIONAL CORPORATION

Report No.: P9590.02-109-18

Date: 08/07/23

SECTION 3

TEST METHOD(S)

The specimen was evaluated in accordance with the following:

TAS 100 (A)-95, *Test Procedure for Wind and Wind Driven Rain Resistance and/or Increased Windspeed Resistance of Soffit Ventilation Strip and Continuous or Intermittent Ventilation System Installed at the Ridge Area*

SECTION 4

MATERIAL SOURCE

Test sample materials were provided by the client from Quickscrews International Corporation located in Livermore, California. Representative samples of the test specimen(s) will be retained by Intertek B&C for a minimum of ten years from the test completion date.

SECTION 5

EQUIPMENT/CALIBRATION

- Vane Axial Fan: Y003346
- Scale: 65571
- Stopwatch: INT00974
- Weather Station: 63317
- Tape Measure Verifier: 63788

Windstream, water supply, and water distribution calibration were performed prior to testing. Reference Intertek B&C Calibration Report No. Q2311.02-109-18, dated 06/22/23, for descriptions and results.

SECTION 6

LIST OF OFFICIAL OBSERVERS

NAME	COMPANY
Melchor C. George	Intertek B&C
Tanya A. Dolby, P.E.	Intertek B&C
Ken R. Stough	Intertek B&C
Christopher E. Sartalis	Intertek B&C



Total Quality. Assured.

130 Derry Court
York, Pennsylvania 17406

Telephone: 717-764-7700
Facsimile: 717-764-4129
www.intertek.com/building

TEST REPORT FOR QUICKSCREWS INTERNATIONAL CORPORATION

Report No.: P9590.02-109-18

Date: 08/07/23

SECTION 7

TEST SPECIMEN DESCRIPTION

Manufacturer: Quickscrews international Corporation

Product Type: Solar Mount

Series / Model: Butyl Bottom Deck Mount (PN#16319/16320),

Roof Deck Description: An 8' 0" wide by 6' 0" long roof deck on a 2:12 slope was utilized. The roof deck consisted of #2 Spruce-Pine-Fir nominal 2x6 intermediate supports sheathed with APA 32/16 span rated 15/32" plywood sheathing. The intermediate supports were spaced 24" on center. The plywood was secured to the rafters with 8d common nails spaced 6" on center around the perimeter and 12" on center at the intermediate supports. 30# felt paper underlayment was utilized over the sheathing. Architectural shingles were then installed on the roof deck.

Solar Mount Description/Installation: The mount was 2-1/4" wide by 5" long by 3-1/2" high. The mount was placed flat 18" down from the ridge in the center of a single tab. Four 2-1/2" lag screws with self-sealing washer were utilized through the base of the mount and butyl in the deck.

Conditioning: The test deck was conditioned in a chamber at a temperature of 135°F for a total of sixteen continuous hours.



Total Quality. Assured.

130 Derry Court
York, Pennsylvania 17406

Telephone: 717-764-7700
Facsimile: 717-764-4129
www.intertek.com/building

TEST REPORT FOR QUICKSCREWS INTERNATIONAL CORPORATION

Report No.: P9590.02-109-18

Date: 08/07/23

SECTION 8

TEST RESULTS

Protocol TAS 100(A)-95, Test Procedure for Wind and Wind Driven Rain Resistance and/or Increased Windspeed Resistance of Soffit Ventilation Strip and Continuous or Intermittent Ventilation System Installed at the Ridge Area.

Test Date(s): 07/13/23

The temperature during testing was 27°C (81°F). The results are tabulated as follows:

Test Procedure: The wind speed intervals were conducted as follows:

Interval No.	Wind Speed (mph)	Time (min)	Water Spray
1	35	15	On
2	0	5	Off
3	70	15	On
4	0	5	Off
5	90	15	On
6	0	5	Off
7	110	5	On
8	0	5	Off

Test Results: The TAS 100(A) test results are as follows:

Wind Speed	Results
35 mph	0.0 oz.
70 mph	0.0 oz.
90 mph	0.0 oz.
110 mph	0.0 oz.

Allowable: 13.92 oz.

Result(s): Pass

Note 1: Tested at a 2:12 roof pitch.



Total Quality. Assured.

130 Derry Court
York, Pennsylvania 17406

Telephone: 717-764-7700
Facsimile: 717-764-4129
www.intertek.com/building

TEST REPORT FOR QUICKSCREWS INTERNATIONAL CORPORATION

Report No.: P9590.02-109-18

Date: 08/07/23

SECTION 9

CONCLUSION

This report does not constitute certification of this product nor an opinion or endorsement by this laboratory. Intertek B&C will service this report for the entire test record retention period. The test record retention period ends ten years after the test date. Test records, such as detailed drawings, datasheets, representative samples of test specimens, or other pertinent project documentation, will be retained for the entire test record retention period.

Unless differently required, Intertek reports apply the "Simple Acceptance" rule, also called "Shared Risk approach," of ILAC-G8:09/2019, Guidelines on Decision Rules and Statements of Conformity.

TEST REPORT FOR QUICKSCREWS INTERNATIONAL CORPORATION

Report No.: P9590.02-109-18

Date: 08/07/23

SECTION 10
PHOTOGRAPHS



Photo No. 1
Top Side Before Testing



Photo No. 2
Underside Before Testing

TEST REPORT FOR QUICKSCREWS INTERNATIONAL CORPORATION

Report No.: P9590.02-109-18

Date: 08/07/23



Photo No. 3
35 MPH Top Side



Photo No. 4
35 MPH Underside

TEST REPORT FOR QUICKSCREWS INTERNATIONAL CORPORATION

Report No.: P9590.02-109-18

Date: 08/07/23



Photo No. 5
70 MPH Top Side



Photo No. 6
70 MPH Underside

TEST REPORT FOR QUICKSCREWS INTERNATIONAL CORPORATION

Report No.: P9590.02-109-18

Date: 08/07/23



Photo No. 7
90 MPH Top side



Photo No. 8
90 MPH Underside

TEST REPORT FOR QUICKSCREWS INTERNATIONAL CORPORATION

Report No.: P9590.02-109-18

Date: 08/07/23



Photo No. 9
110 MPH Top Side



Photo No. 10
110 MPH Underside

TEST REPORT FOR QUICKSCREWS INTERNATIONAL CORPORATION

Report No.: P9590.02-109-18

Date: 08/07/23



Photo No. 11
Post Test Top Side



Photo No. 12
Post Test Underside



DEPARTMENT OF REGULATORY AND ECONOMIC RESOURCES (RER)
BOARD AND CODE ADMINISTRATION DIVISION
NOTICE OF ACCEPTANCE (NOA)

MIAMI-DADE COUNTY
PRODUCT CONTROL SECTION
11805 SW 26 Street, Room 208
Miami, Florida 33175-2474
T (786) 315-2590 F (786) 315-2599
www.miamidade.gov/economy

Quickscrews Int'l Corp.
5830 Las Positas Rd.
Livermore, CA 94551

SCOPE:

This NOA is being issued under the applicable rules and regulations governing the use of construction materials. The documentation submitted has been reviewed and accepted by Miami-Dade County RER-Product Control Section to be used in Miami-Dade County and other areas where allowed by the Authority Having Jurisdiction (AHJ).

This NOA shall not be valid after the expiration date stated below. The Miami-Dade County Product Control Section (In Miami-Dade County) and/ or the AHJ (in areas other than Miami-Dade County) reserve the right to have this product or material tested for quality assurance purposes. If this product or material fails to perform in the accepted manner, the manufacturer will incur the expense of such testing and the AHJ may immediately revoke, modify, or suspend the use of such product or material within their jurisdiction. RER reserves the right to revoke this acceptance if it is determined by Miami-Dade County Product Control Section that this product or material fails to meet the requirements of the applicable building code.

This product is approved as described herein and has been designed to comply with the Florida Building Code, including the High Velocity Hurricane Zone.

DESCRIPTION: QuickBOLT Butyl Bottom Stainless Steel Deck Solar Mount

APPROVAL DOCUMENT: Drawing No. **QBDM-HZ**, titled "QuickBOLT Butyl Deck Mount Solar Bracket" Microflashing", sheets 1 through 2 of 2, prepared by QuickBolt a div of Quickscrews Int'l Corp., dated on 03/14/2024, signed and sealed by Scott Wolters, P.E., bearing the Miami-Dade County Product Control approval stamp with the Notice of Acceptance number and approval date by the Miami-Dade County Product Control Section.

MISSILE IMPACT RATING: None

LABELING: Each box shall bear a permanent label with the manufacturer's name or logo, city, state and following statement: "Miami-Dade County Product Control Approved or MDCPCA", unless otherwise noted herein.

RENEWAL of this NOA shall be considered after a renewal application has been filed and there has been no change in the applicable building code negatively affecting the performance of this product.

TERMINATION of this NOA will occur after the expiration date or if there has been a revision or change in the materials, use, and/or manufacture of the product or process. Misuse of this NOA as an endorsement of any product, for sales, advertising or any other purposes shall automatically terminate this NOA. Failure to comply with any section of this NOA shall be cause for termination and removal of NOA.

ADVERTISEMENT: The NOA number preceded by the words Miami-Dade County, Florida, and followed by the expiration date may be displayed in advertising literature. If any portion of the NOA is displayed, then it shall be done in its entirety.

INSPECTION: A copy of this entire NOA shall be provided to the user by the manufacturer or its distributors and shall be available for inspection at the job site at the request of the Building Official.

This NOA consists of this page 1, evidence page E-1, as well as approval document mentioned above.

The submitted documentation was reviewed by **Carlos M. Utrera, P.E.**



04/17/24

NOA No: 23-1122.07
Expiration Date: April 25, 2029
Approval Date: April 25, 2024
Page 1

NOTICE OF ACCEPTANCE: EVIDENCE SUBMITTED

A. DRAWINGS

1. Drawing No. **QBDM-HZ**, titled “QuickBOLT Butyl Deck Mount Solar Bracket” Microflashing”, sheets 1 through 2 of 2, prepared by QuickBolt a div of Quickscrews Int'l Corp., dated on 03/14/2024, signed and sealed by Scott Wolters, P.E.

B. TESTS

1. Test report on Uplift and Shear Allowable Loads of the Butyl Bottom Deck Mounts per ASTM D7147-21, prepared by Intertek, Test Report No. **Q6437.01-106-18 R2**, dated 11/17/2023, with revision dated 03/25/2024, signed and sealed by Tanya A. Dolby, P.E.
2. Test report on Wind Driven Rain Resistance of the Butyl Bottom Deck Mounts per TAS 100(A)-95, prepared by Intertek, Test Report No. **P9590.02-109-18**, dated 08/07/2023, signed and sealed by Tanya A. Dolby, P.E.

C. CALCULATIONS

1. Anchor calculations prepared by Wolters Engineering, Inc., dated 02/13/2024, signed and sealed by Scott Wolters, P.E.

D. MATERIAL CERTIFICATIONS

1. None.

E. QUALITY ASSURANCE

1. Miami-Dade Department of Regulatory and Economic Resources (RER).

F. STATEMENTS

1. Statement letter of code conformance to the 8th edition (2023) of the FBC, issued by Wolters Engineering, Inc., dated 02/13/2024, signed and sealed by Scott Wolters, P.E.
2. Statement letter of no financial interest, issued by Wolters Engineering, Inc., dated 02/13/2024, signed and sealed by Scott Wolters, P.E.
3. Distributor agreement dated 01/17/2024.



Carlos M. Utrera, P.E.
Product Control Examiner
NOA No: 23-1122.07
Expiration Date: April 25, 2029
Approval Date: April 25, 2024

E - 1

QUICKBOLT PN 16319/16320 BUTYL DECK MOUNT SOLAR BRACKET

GENERAL NOTES:

1. THIS SYSTEM HAS BEEN DESIGNED AND TESTED TO MEET ALL OF THE REQUIREMENTS OF THE 8TH EDITION (2023) FLORIDA BUILDING CODE, INCLUDING THE HVHZ PROVISIONS.
2. THIS SYSTEM HAS BEEN TESTED PER TAS 100(A) AND ASTM D7147.
3. THE DESIGN OF THE SUBSTRATE IS THE RESPONSIBILITY OF THE ENGINEER OF RECORD OR OTHER SPECIALTY ENGINEER, AND IS NOT A PART OF THIS APPROVAL. THE SUBSTRATE MUST SAFELY TRANSMIT THE LOADS APPLIED TO THIS SYSTEM TO THE BUILDING STRUCTURE.
4. FIRE RATINGS OR FIRE RESISTANCE IS NOT A PART OF THIS REVIEW.
5. ALL ANCHORS SECURING THE SYSTEM TO PRESSURE TREATED WOOD SHALL BE CAPABLE OF RESISTING CORROSION CAUSED BY THE CHEMICALS IN THE WOOD.
6. MATERIALS INCLUDING BUT NOT LIMITED TO STEEL/METAL SCREWS THAT COME INTO CONTACT WITH OTHER DISSIMILAR MATERIALS SHALL BE PROTECTED PER FBC REQUIREMENTS.
7. NO INCREASE IN ALLOWABLE STRESS HAS BEEN USED IN THE DESIGN OF THIS PRODUCT. Cd=1.6 WAS USED FOR WOOD SCREWS ONLY.
8. THE ALLOWABLE LOADS SHOWN ARE BASED ON FASTENING TO THE 19/32" (min) PLYWOOD SHEATHING ONLY. THE SHEATHING AND ITS CONNECTION TO SUPPORTS/RAFTERS ARE NOT A PART OF THIS APPROVAL, AND MUST BE VERIFIED BY THE ENGINEER OF RECORD.
9. BRACKET FASTENERS MUST FULLY PENETRATE THE 19/32" (min) SHEATHING, WITH 3 THREADS (min) BEYOND.

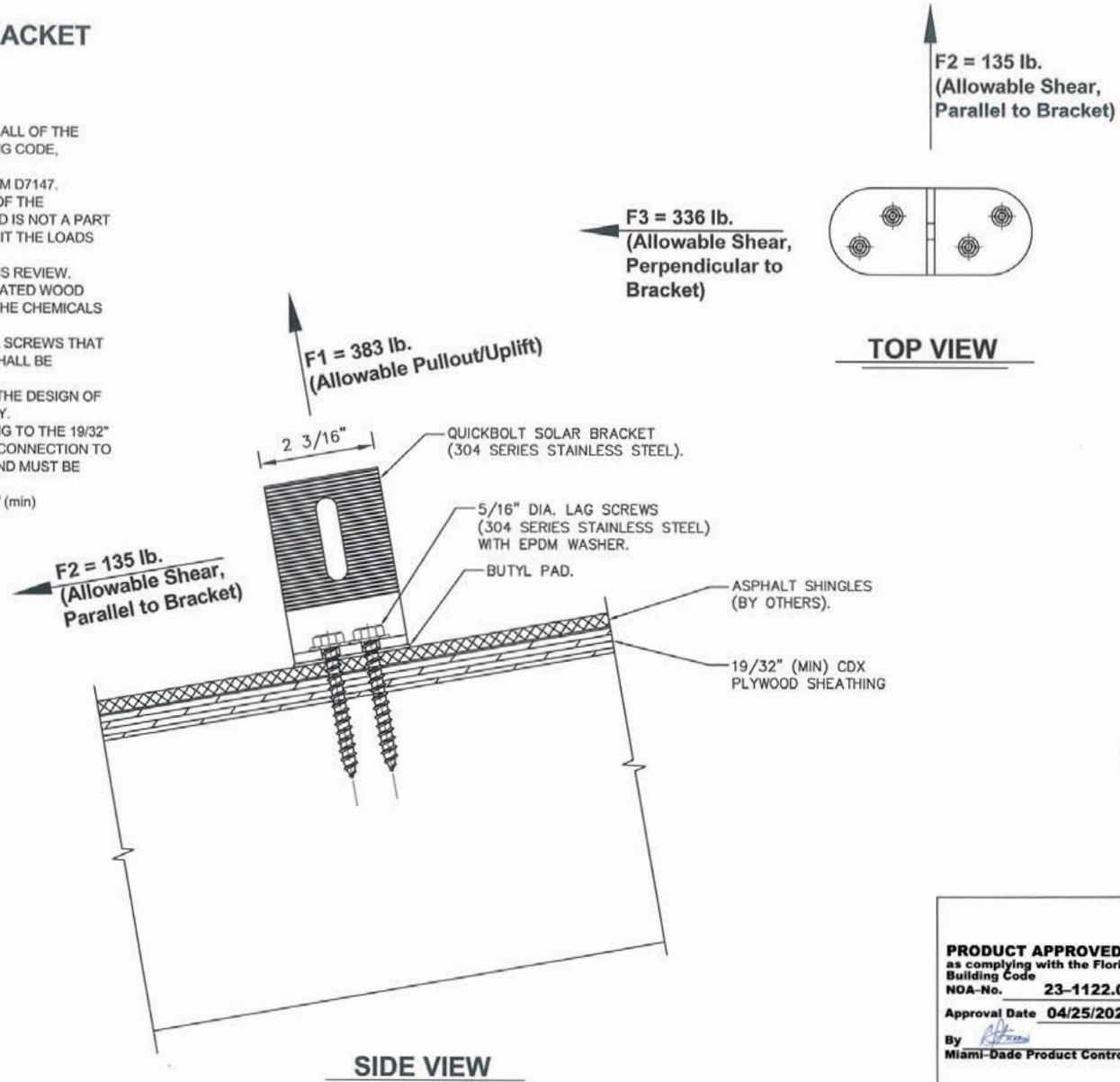

REVISION	DATE	REV.#	DATE
1	3/14/24		
1ST SUBMITTAL	2/2/24		

QuickBOLT
World's First UL Certified Microflashing®
5830 Las Positas Rd
Livermore, CA 94551
PH: (844) 671-6045
WWW.QUICKBOLT.COM



PRODUCT APPROVED
as complying with the Florida
Building Code
NOA-No. **23-1122.07**
Approval Date **04/25/2024**
By *[Signature]*
Miami-Dade Product Control

SCOTT WALTERS
FL PE# 62354
WALTERS ENGINEERING
(CO# 27194)
15211 07TH ROAD N 33412
WEST PALM BEACH, FL 33412
PH/FAX: (561) 225-1962

PRODUCT:
**QUICKBOLT BUTYL
DECK MOUNT
SOLAR BRACKET**
DWG: **QBDM-HZ**
SHEET: **1/2**

**QUICKBOLT PN 16319/16320
BUTYL DECK MOUNT SOLAR BRACKET**

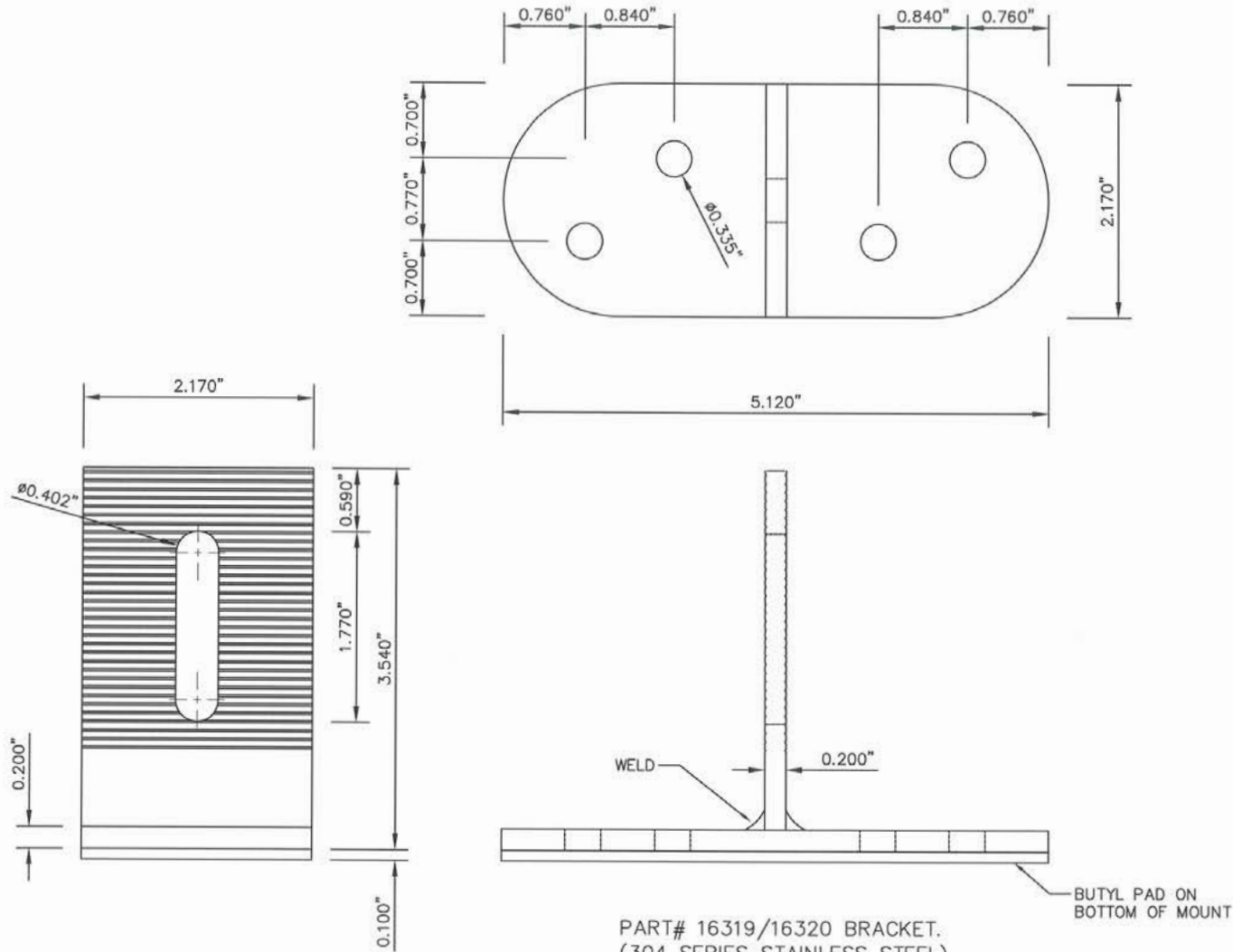

PART# 16319/16320 BRACKET.
(304 SERIES STAINLESS STEEL).

REV.#	DATE	DESCRIPTION
1	3/14/24	1ST SUBMITTAL
2	2/2/24	PRINTS ISSUED FOR

QuickBOLT
World's First UL Certified Microfastening®
5830 LAS POSITAS RD PH: (844) 671-6045
LIVERMORE, CA 94551 WWW.QUICKBOLT.COM

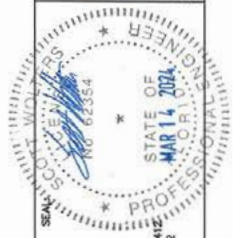

SCOTT WALTERS
FL PE# 62354
WALTERS ENGINEERING
LLC (COMP. 27194)
15211 97TH ROAD N.W. #412
WEST PALM BEACH, FL 33412
PH/FAX: (561) 225-1882

PRODUCT APPROVED
as complying with the Florida
Building Code
NOA-No. **23-1122.07**
Approval Date **04/25/2024**
By *[Signature]*
Miami-Dade Product Control

PRODUCT:
**QUICKBOLT BUTYL
DECK MOUNT
SOLAR BRACKET**
DWG: **QBDM-HZ**
SHEET: **2/2**