

17721 SS

17664, 17720

LOW PROFILE QUICKBOLT WITH 4" MICROFLASHING®
FOR ASPHALT SHINGLE ROOFS
PATENT # 8448407

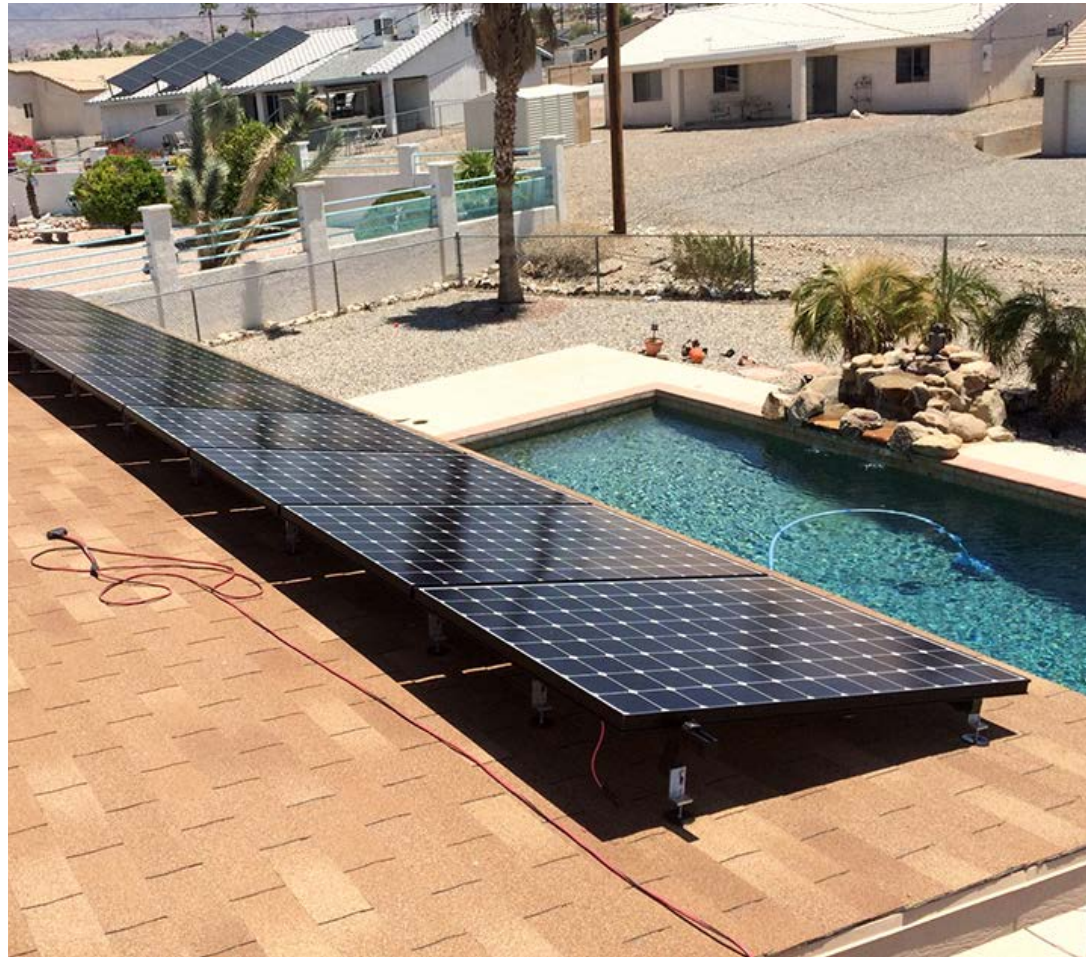

A DIVISION OF QUICKSCREWS INTERNATIONAL CORP

TABLE OF CONTENTS

3

SPEC SHEET

QTY & MEASUREMENT INFORMATION

6

UL CERTIFICATION

PROOF OF UL CERTIFICATION

8

INSTALLATION INSTRUCTIONS

STEP-BY-STEP-INSTALLATION GUIDE

9

BUILDING CODE LETTER

REGARDING STAMP DATES

10

ENGINEERING REPORT

UPLIFT & LATERAL LOAD TEST

14

CHEMLINK COMPATIBILITY LETTER

OPTIONAL SEALANT

SPEC SHEET

Part #	Box Quantity
17664	5.25" Bolts (10)
17720	4" Microflashing® (10); 5.25" Bolts (10)
17721 SS	4" Microflashing® (20); 5.25" Bolts (20); L-Foot (20); 5/16" Serrated Hex Flange Nuts (20)



Part #17664

5/16-18 X 5.25"
304 Stainless Steel
Removable Hanger Bolts

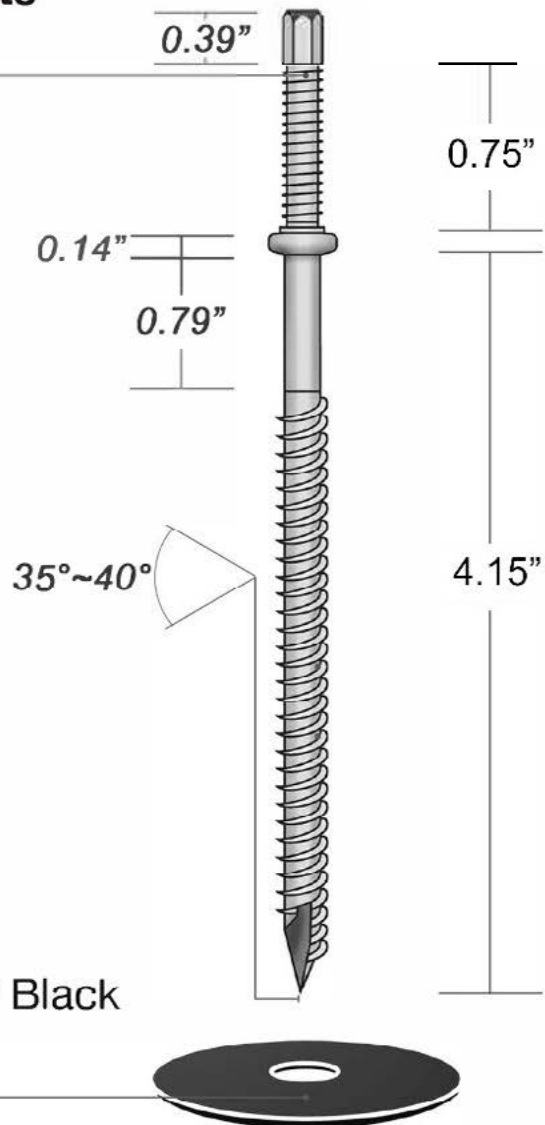

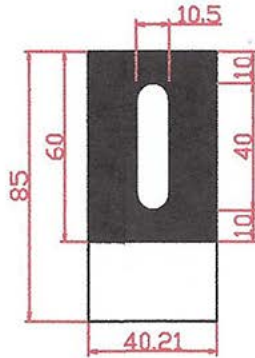
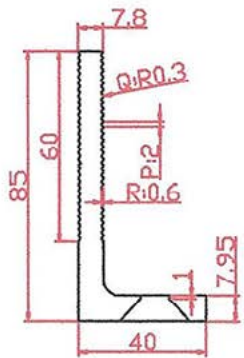

Baiting tolerance	± 2 mm
Hole tolerance	± 0.5 mm
Hole distance tolerance	± 0.5 mm
Form tolerance	± 2 mm
Thickness tolerance	± 0.1 mm
Angle tolerance	$\pm 1^\circ$ mm

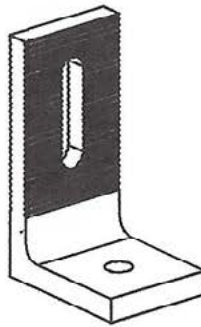
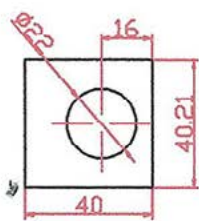
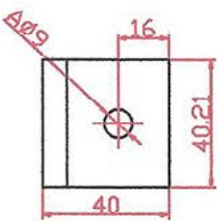

CERTIFICATE OF COMPLIANCE

Certificate Number E493748
Report Reference E493748-20170817
Date 2023-April-07

Issued to: QuickBOLT a Division of Quickscrews International Corp
5830 Las Positas Rd
Livermore CA, 94551 US

This is to certify that representative samples of MOUNTING SYSTEMS, MOUNTING DEVICES, CLAMPING DEVICES AND GROUND LUGS FOR USE WITH PHOTOVOLTAIC MODULES AND PANELS - COMPONENT
See Addendum Page for Product Designation(s).

Have been evaluated by UL in accordance with the component requirements in the Standard(s) indicated on this Certificate. UL Recognized components are incomplete in certain constructional features or restricted in performance capabilities and are intended for installation in complete equipment submitted for investigation to UL LLC.

Standard(s) for Safety: UL 2703, Mounting systems, mounting devices, clamping/retention devices, and ground lugs for use with flat-plate photovoltaic modules and panels-.

Additional Information: See the UL Online Certifications Directory at <https://iq.ulprospector.com> for additional information

This Certificate of Compliance indicates that representative samples of the product described in the certification report have met the requirements for UL certification. It does not provide authorization to apply the UL Recognized Component Mark. Only the Authorization Page that references the Follow-Up Services Procedure for ongoing surveillance provides authorization to apply the UL Mark.

Only those products bearing the UL Recognized Component Mark should be considered as being UL Certified and covered under UL's Follow-Up Services.

Look for the UL Recognized Component Mark on the product.



Deborah Jennings-Conner, VP Regulatory Services

UL LLC

Any information and documentation involving UL Mark services are provided on behalf of UL LLC (UL) or any authorized licensee of UL. For questions, please contact a local UL Customer Service Representative at <http://ul.com/aboutul/locations/>



CERTIFICATE OF COMPLIANCE

Certificate Number E493748
Report Reference E493748-20170817
Date 2023-April-07

This is to certify that representative samples of the product as specified on this certificate were tested according to the current UL requirements

Models:

USR – Component, Roof Mounting Hook Units, Models 15891 15893 15987 16000 16317 16318 16319 16320 16988 16990 16991 16993 17508 17509 17510 17511 17512 17513 17514 17515 17516 17517 17518 17519 17520 17521 17522 17523 17524 17525 17526 17527 17536 17537 17538 17539 17540 17541 17542 17543 17544 17545 17546 17547 17548 17549 17550 17551 17552 17553 17554 17555 17556 17558 17559 17560 17566 17567 17568 17569 17570 17571 17572 17573 17574 17575 17576 17577 17578 17579 17580 17585 17586 17587 17588 17589 17592 17596 17597 17598 17599 17600 17601 17606 17607 17608 17609 17610 17611 17612 17613 17614 17615 17616 17617 17618 17620 17621 17622 17623 17624 17625 17626 17627 17628 17629 17630 17631 17632 17633 17636 17637 17638 17639 17640 17641 17642 17643 17646 17647 17648 17649 17650 17651 17652 17653 17654 17659 17664 17667 17669 17670 17671 17672 17673 17678 17679 17680 17681 17686 17687 17688 17689 17700 17701 17702 17703 17704 17705 17706 17707 17708 17709 17710 17711 17712 17717 17718 17750 17751 17752 17753 17759 15891-10 15891BLK-10 15987A 15987B 17667SS 17672SS 17680SS 17688SS 17713SS 17720 17721SS 17723 17724SS 17726 17727SS 17729 17730SS 15894SS 15891SS 15987BSS 17660 17661 17662 17663 17747 17748

Deborah Jennings-Conner

Deborah Jennings-Conner, VP Regulatory Services

UL LLC

Any information and documentation involving UL Mark services are provided on behalf of UL LLC (UL) or any authorized licensee of UL. For questions, please contact a local UL Customer Service Representative at <http://ul.com/aboutul/locations/>



INSTALL INSTRUCTIONS



RECOMMENDED MATERIALS

- Rafter locator
- Chalk or a crayon
- Drill with a 3/16" drill bit
- MFG approved sealant
- M6 deep socket hex driver
- 1/2" wrench

INSTALLATION INSTRUCTIONS

1. Locate the rafter and predrill the hole
2. Fill the predrilled hole with MFG approved sealant
3. Place a ring of sealant around the bottom of the Microflashing® washer
4. Place the Microflashing® and drive the bolt until it compresses
5. Insert the L-Foot
6. Insert the nut and tighten until secure

To compress Microflashing® properly with QuickBOLT use a 125 minimum torque lbs/inch



BUILDING CODE LETTER



March 22nd, 2023

To whom this may concern,

QuickBOLT is committed to excellence. The parts tested are durable goods, meaning the material composition and detailed specifications of the parts do not change. Therefore, all stamps are current. Any part tested will have the same results no matter what year the tests are performed. All testing and reports are current and valid with 2022 CBC standards.

SolarRoofHook is the previous name of QuickBOLT. Any test result referencing SolarRoofHook is referring to a QuickBOLT product.

All our parts were tested by a third-party test facility, in possession of a current engineering license for the state where the tests were performed for the following.

1. Uplift test
2. Downward load test
3. Lateral Test – Asphalt Mounts, and Metal Mounts only
4. ASTM E2440 and ASTM E330 Waterproof Tests - QuickBOLT only

The following is an excerpt from:

CALIFORNIA BOARD FOR PROFESSIONAL ENGINEERS AND LAND SURVEYORS
guide to Engineering & Land Surveying for City and County Officials
Page 12, Line 27

27. If the license has expired between the time the engineering documents were prepared and the time when the local agency's review is performed, do the documents need to be re-sealed by a licensee with a current license? (B&P Code §§ 6733, 6735, 6735.3, 6735.4)

As long as the license was current at the time the engineering documents were prepared, the documents do not need to be re-sealed prior to review by the local agency. However, any changes (updates or modifications) to the documents that are made following the review by the local agency would have to be prepared by a licensed engineer with a current license and those changes would have to be signed and sealed.

We trust the information provided will resolve any request for the test reports submitted to have a stamp from the current year.

Regards,

Rick Gentry
Executive Vice President

ENGINEERING REPORT



APPLIED MATERIALS & ENGINEERING, INC.

980 41st Street
Oakland, CA 94608

Tel: (510) 420-8190
FAX: (510) 420-8186
e-mail: info@appmateng.com

February 14, 2018

Mr. Rick Gentry
SolarRoofHook
a division of Quickscrews International Corp.
5830 Las Positas Road
Livermore, CA 94551

Project Number 1180031C

Subject: L-Foot 4mm w/ Low Profile 5-1/4" QuickBOLT
Part #15894SS with Part #17664 Laboratory Load Testing

Dear Mr. Gentry:

As requested, Applied Materials & Engineering, Inc. (AME) has completed load-testing the L-Foot 4mm (Part #15894SS) with the Low Profile 5-1/4" QuickBOLT (Part #17664); see Appendix A, Figure A1 and Figure A2, respectively. The purpose of our testing was to evaluate the lateral and tensile (uplift) load capacity of the L-Foot 4mm connecting member attached to a 2"x4" Douglas Fir rafter using one Low Profile 5/16"Øx5-1/4" QuickBOLT.

SAMPLE DESCRIPTION

Mockup samples were delivered to our laboratory on January 10, 2018. Mockup configuration consisted of three 12" long rafters at 6.5" o.c., screwed to 1/2" OSB. One 5/16"Øx5-1/4" QuickBOLT was screwed through the Microflashing™ (sold as Part #17669) and then through the OSB into a rafter. The L-Foot 4mm is fastened to the QuickBOLT using one 5/16" 18-8 Stainless Steel Flange Nut.

TEST PROCEDURES & RESULTS

1. Lateral Load Test

A total of three tests were conducted for lateral load capacity on January 12, 2018 using a United Universal testing machine. Samples were rigidly attached to the testing machine and a lateral load was applied to each L-foot. The samples were loaded in shear at a constant rate of axial deformation of 0.10 in. /min. without shock until failure occurred; displacement at maximum load was recorded. Based on the above testing, the average maximum lateral load of the L-Foot 4mm attached to a 2"x4" Douglas Fir rafter using one Low Profile 5/16"Øx5-1/4" QuickBOLT was determined to be 508 lbf. Detailed results are provided in Table I and Figure 1. Test setup and mode of failure are provided in Appendix B, Figure B1.

The specific gravity and moisture content of each rafter was tested in accordance with ASTM D2395, Method A (oven-dry). The average specific gravity and average moisture content of the three samples were determined to be 0.416 and 10.8%, respectively.

Mr. Rick Gentry
SolarRoofHook
L-Foot 4mm w/ Low Profile 5-1/4" QuickBOLT
Part #15894SS with Part #17664 Laboratory Load Testing
February 14, 2018

Project Number 1180031C

2. Tensile (Uplift) Load Test

A total of three tests were conducted for tensile (uplift) load capacity on January 16, 2018 using a United Universal testing machine. Samples were rigidly attached to the testing machine and an uplift (tensile) load was applied to each L-foot. The samples were loaded in tension at a constant rate of axial deformation of 0.10 in. /min. without shock until failure occurred; displacement at maximum load was recorded. Based on the above testing, the average maximum uplift load of the L-Foot 4mm attached to a 2"x4" Douglas Fir rafter using one Low Profile 5/16"Øx5-1/4" QuickBOLT was determined to be 3277 lbf. Detailed results are provided in Table II and Figure 2. Test setup and mode of failure are provided in Appendix B, Figure B2.

The specific gravity and moisture content of the rafter was tested in accordance with ASTM D2395, Method A (oven-dry). The average specific gravity and average moisture content of the three samples were determined to be 0.402 and 11.1%, respectively.

Respectfully Submitted,

APPLIED MATERIALS & ENGINEERING, INC.

Joseph Gapuz

Joseph Gapuz
Laboratory Manager

Reviewed by:



Tajirian
Armen Tajirian, Ph.D., P.E.
Principal

TABLE I

LATERAL LOAD TEST RESULTS

L-FOOT 4MM

PART #15894SS w/ LOW PROFILE 5/16"Øx5-1/4" QUICKBOLT (PART #17664)

PROJECT NUMBER 1180031C

TEST NUMBER	MAXIMUM LATERAL LOAD (lbf)	DISPLACEMENT AT MAXIMUM LOAD (in.)	MODE OF FAILURE	RAFTER SPECIFIC GRAVITY	RAFTER MOISTURE CONTENT (%)
999	552	3.5	Test Fixture Contacted Plywood	0.398	10.9
1000	498	3.5		0.413	11.7
1001	475	3.5		0.438	9.7
AVERAGE	508	3.5	..	0.416	10.8

FIGURE 1

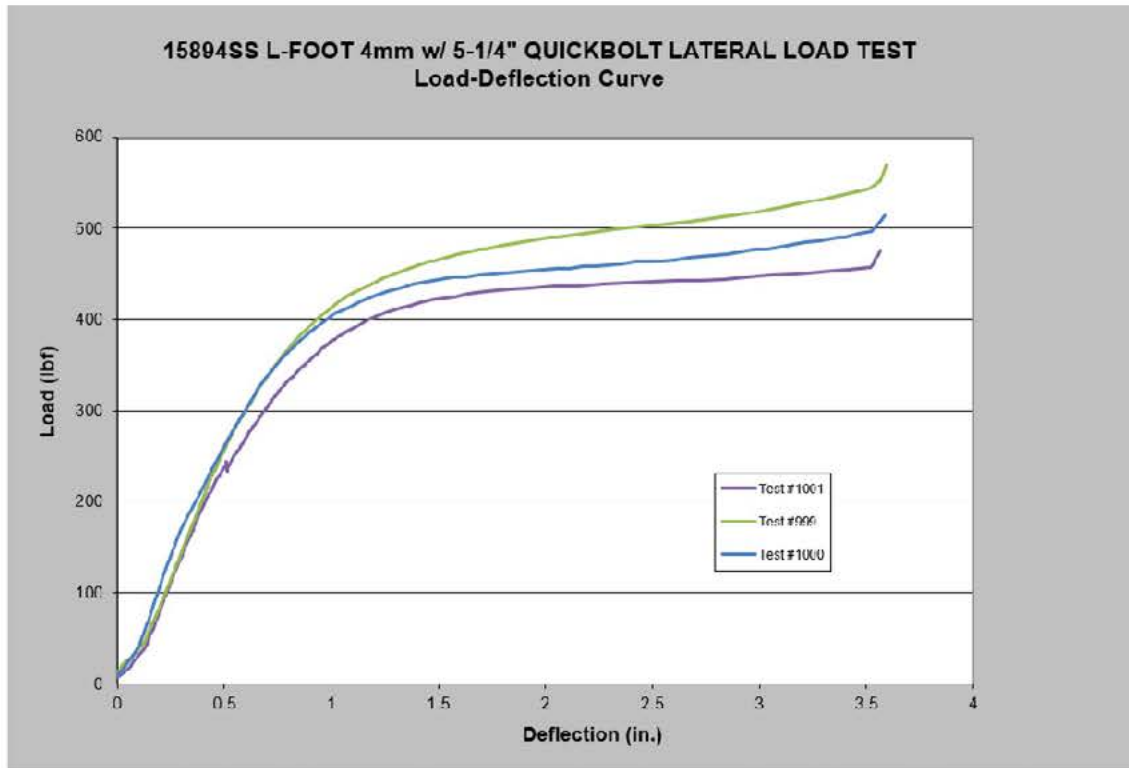

Note: Maximum load recorded at moment fixture contacts plywood; see Appendix B for image of failure mode.

TABLE II

TENSILE (UPLIFT) LOAD TEST RESULTS

L-FOOT 4MM

PART #15894SS w/ LOW PROFILE 5/16"Øx5-1/4" QUICKBOLT (PART #17664)

PROJECT NUMBER 1180031C

TEST NUMBER	MAXIMUM TENSILE LOAD (lbf)	DISPLACEMENT AT MAXIMUM LOAD (in.)	MODE OF FAILURE	RAFTER SPECIFIC GRAVITY	RAFTER MOISTURE CONTENT (%)
914	3397	0.8	QuickBOLT Pull-out	0.395	10.1
918	3191	0.8		0.431	11.5
919	3242	0.8		0.381	11.9
AVERAGE	3277	0.8	..	0.402	11.1

FIGURE 2

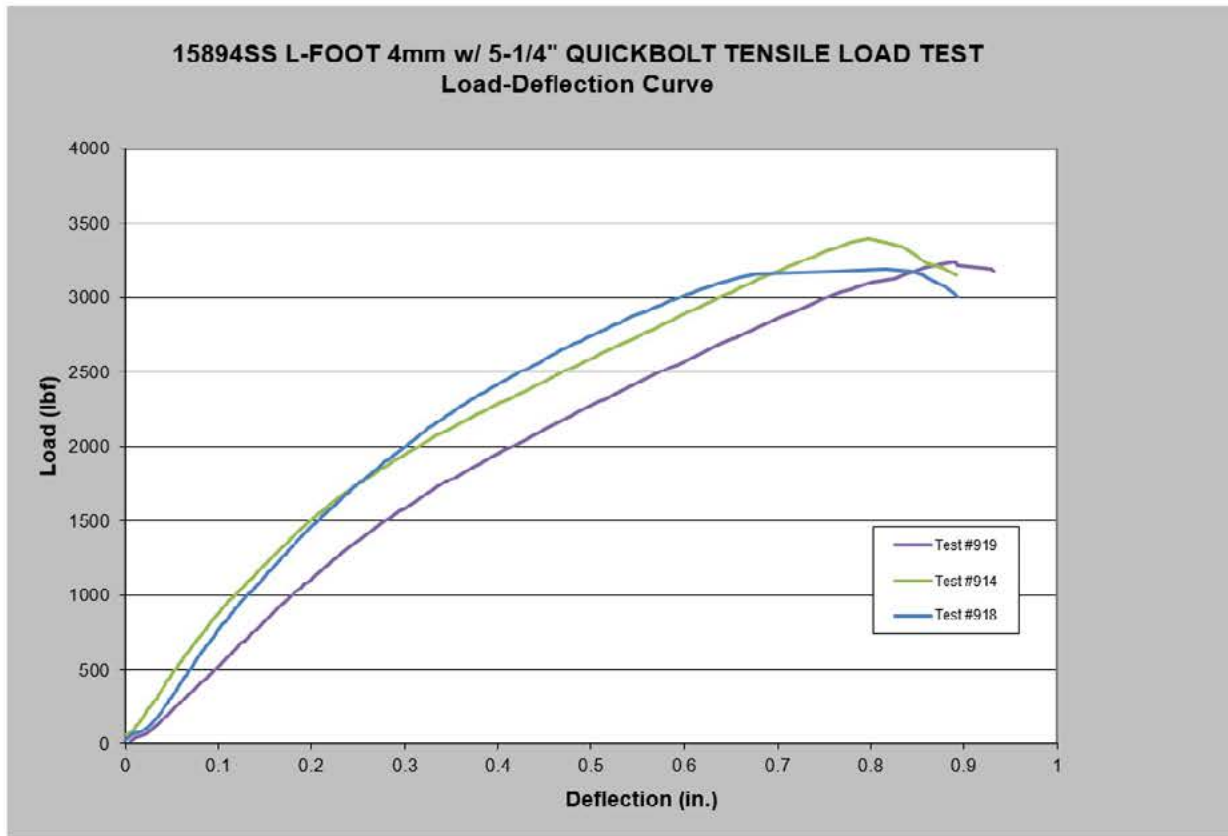

CHEMLINK COMPATIBILITY



February 15, 2023

ATTN: Rick Gentry, Executive VP

QuickBolt

5830 Las Positas Blvd.

Livermore, California 94551

Subject: Product compatibility:

This letter is regarding the compatibility of the ChemLink M-1® Universal Adhesive and Sealant with the Microflashing® by QuickBolt. My testing indicated that there are no known compatibility issues with Microflashing® and M-1® when they are used as directed. Acceptable adhesion was achieved within seven days of application. The M-1® adhesive / sealant was applied at 70° Fahrenheit and 50% percent relative humidity.

All surfaces should be clean, dry, and free of all contaminants. Use isopropyl alcohol to prepare surfaces. Do not use mineral spirits or xylene.

Thank you,

Rick Berthiaume

Technical Services Manager

353 E LYONS STREET SCHOOLCRAFT, MICHIGAN 48087 PH 268.879.4440 TOLL FREE 800.826.1681 FAX 268.879.4448 WWW.CHEMLINK.COM